

Lot 19



Glen Estate

64-66 GLEN RD, STOKES VALLEY

Lot 19



Lot 19



Lot 19



Lot 19

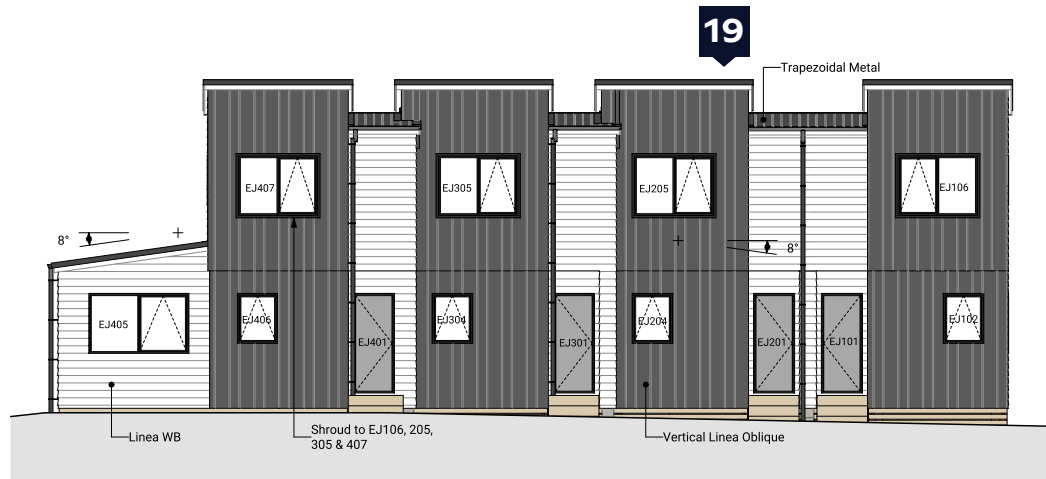

1 North East Elevation

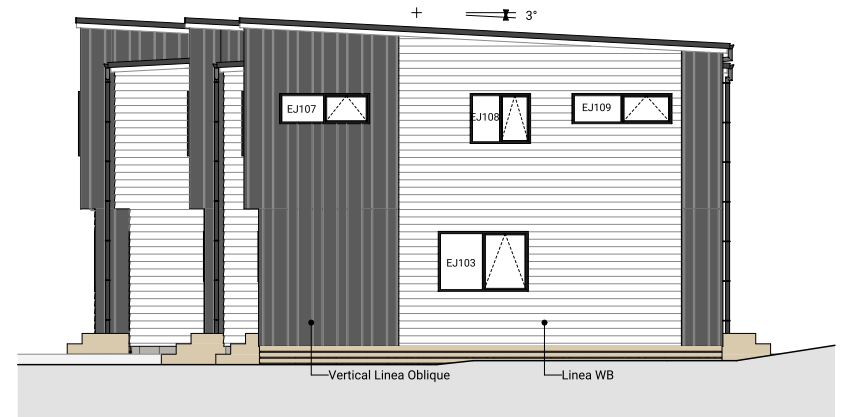

2 North West Elevation



3 South West Elevation

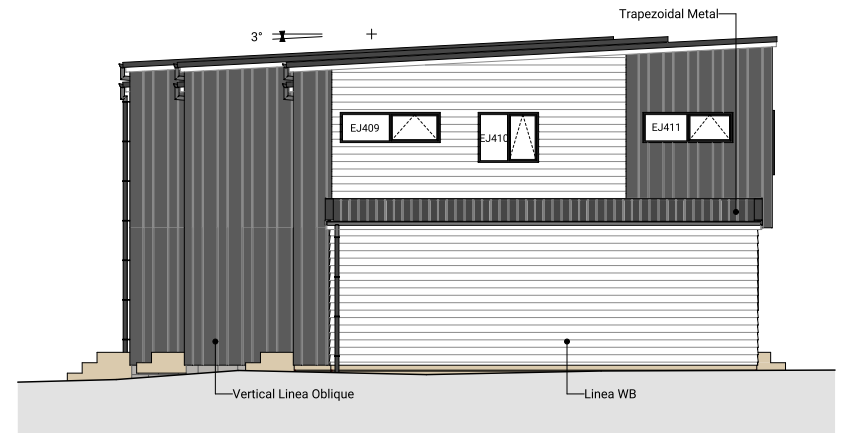

4 South East Elevation

Lot 19

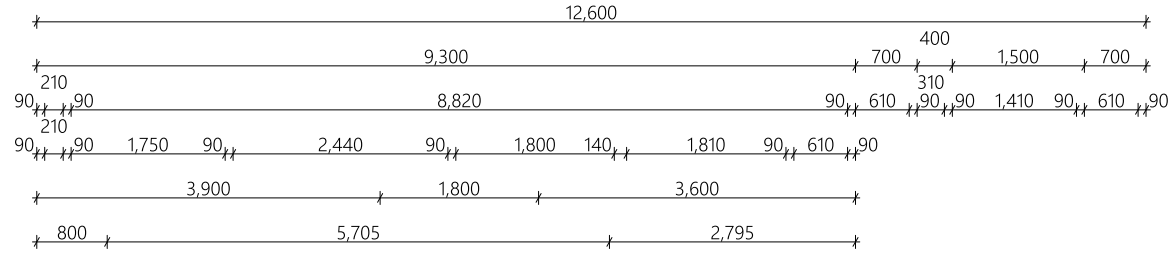

Lot 19 Floor Area	
Lower Floor Area	35.7m ²
Upper Floor Area	36.7m ²
Total Floor Area	72.4m²

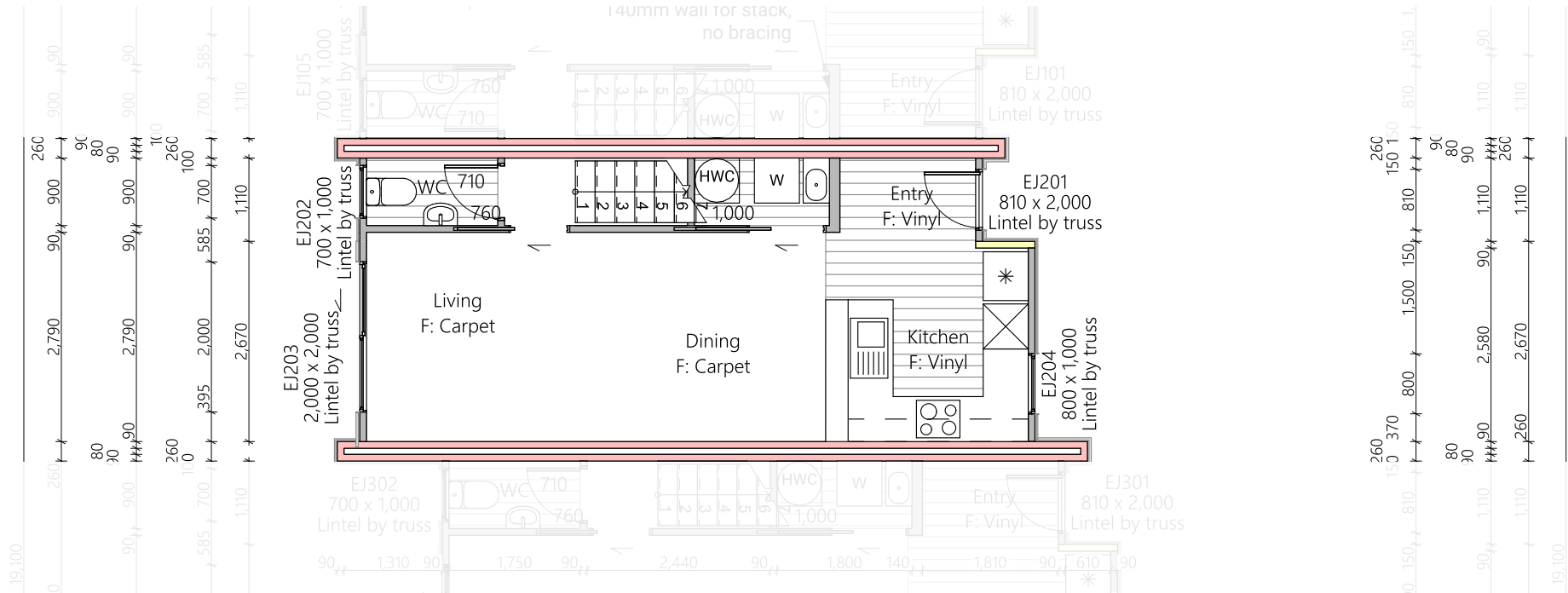

Lot 19

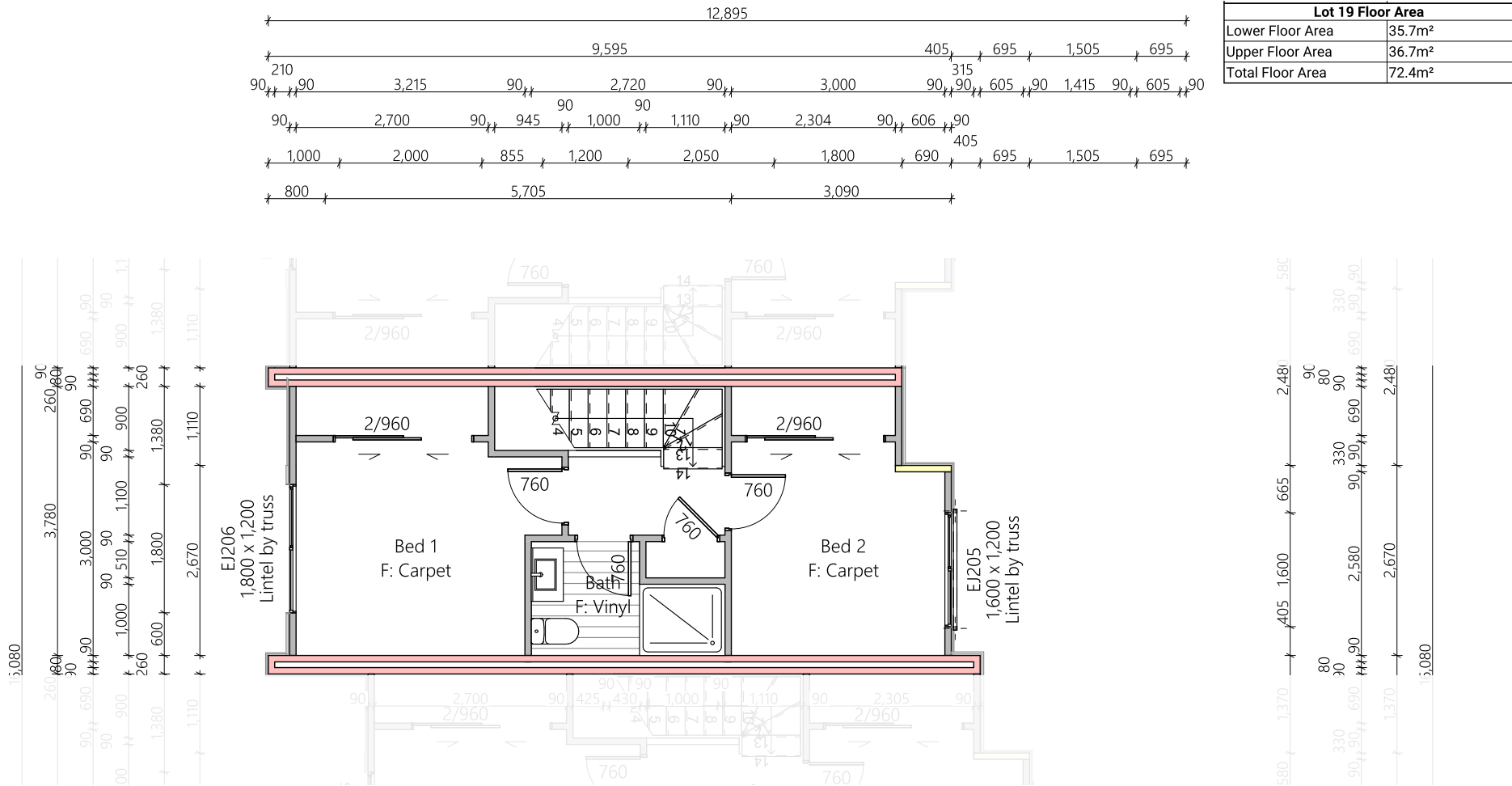

Lot 19

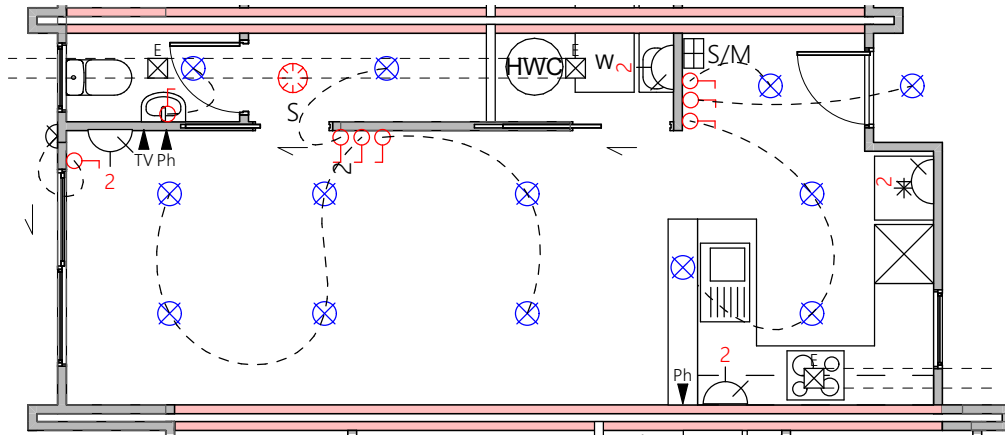

Lower Electrical Plan

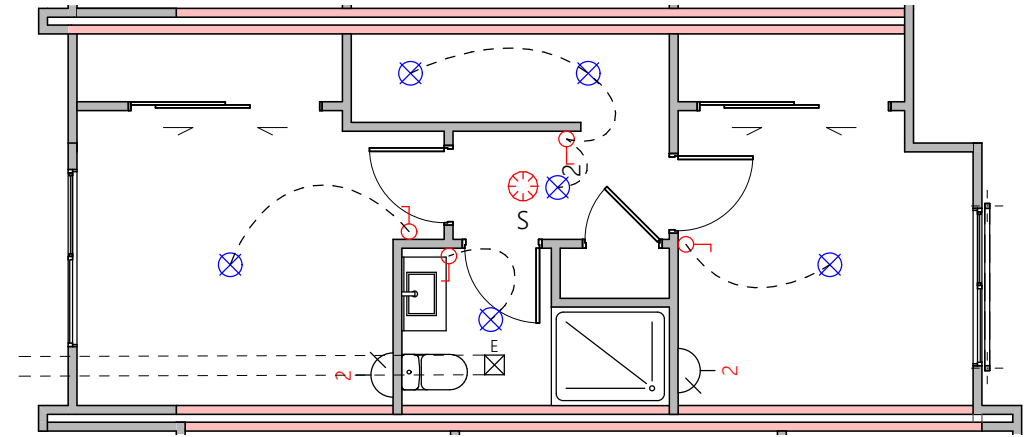

Upper Electrical Plan

S/M	Smart Meter	Power point	Light switch
G	Garage door motor	Phone outlet	Two way light switch
S	Smoke detector	Television outlet	Recessed downlight
E	Extractor fan		

Lot 19

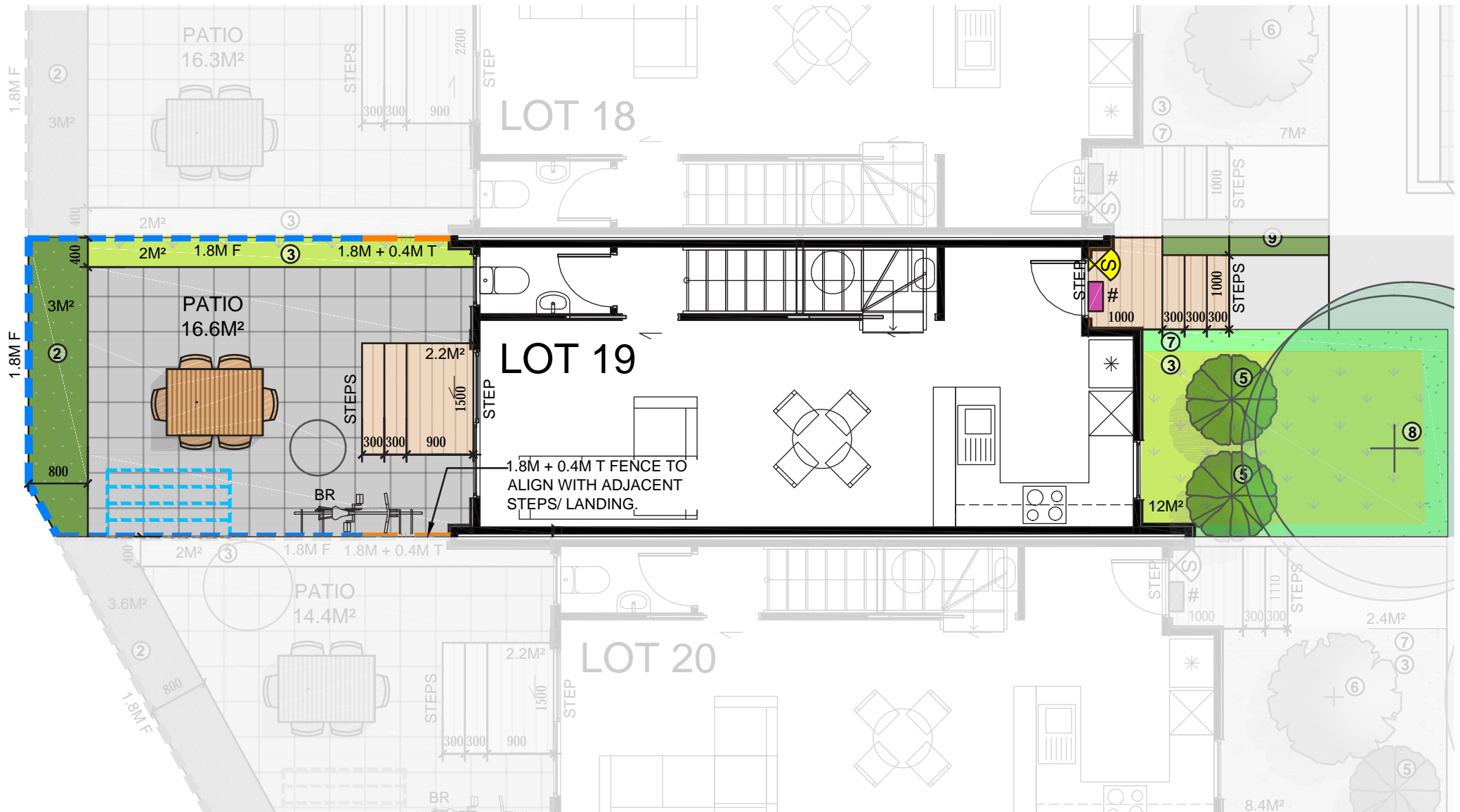

Lot 19

	Product	Colour/Finish
EXTERIOR LOT 19		
Roof	Colorsteel Trapezoidal	Flaxpod
Fascia/Barge Boards	Colorsteel	Flaxpod
Spouting	Colorsteel	Flaxpod
Downpipes	Colorsteel Marley PVC Colour (if retention tank)	Flaxpod OR Ironsand
Retention Tank (if required)	Thin Tanks NZ	Surf Mist
Soffits/Eaves	Painted	Wattyl Enclose Half
Cladding 1	Linea Weatherboards (painted) & Timber Posts at entry	Wattyl Wet Cement Half
Cladding 2	Axon Vertical (painted)	Wattyl Mintaro Slate
Cladding 3	Rockcote Plaster (painted)	Resene Half Black White
Concrete Letterbox	Painted	Wattyl Enclose Half
Aluminium Joinery (with clear glass)	Powdercoated	Flaxpod
(Residential Hardware to all aluminium joinery is colour matched to joinery)		
Front Door	Vertical Groove	Flaxpod
Front Door Handle	Residential Lever Hardware	Powdercoat finish matched to door

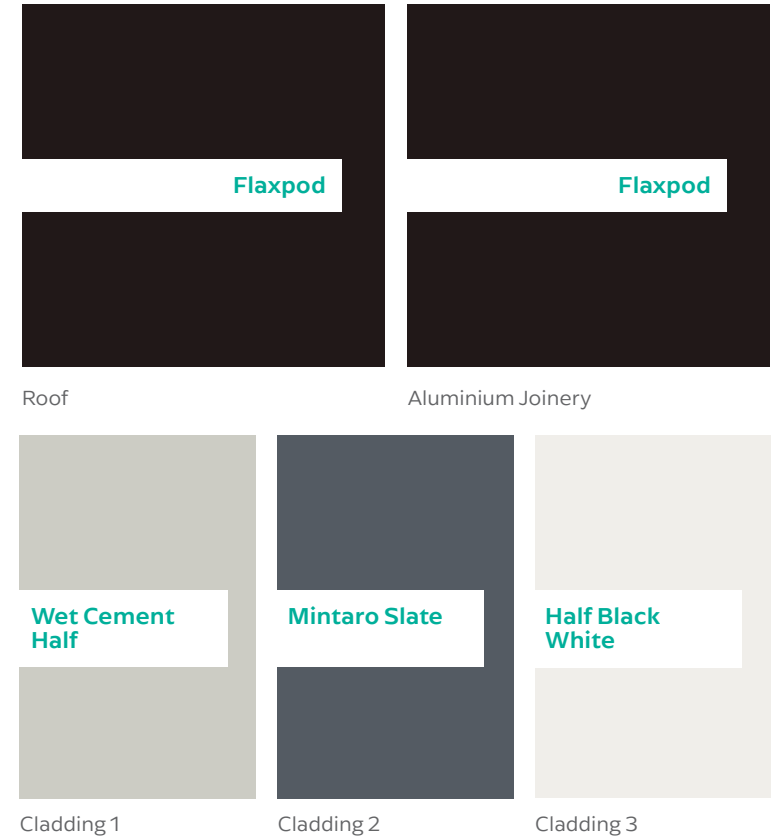

All colour swatches are indicative only