

**Lot 3**



**41-43 Main Rd**

**WAINUIOMATA**



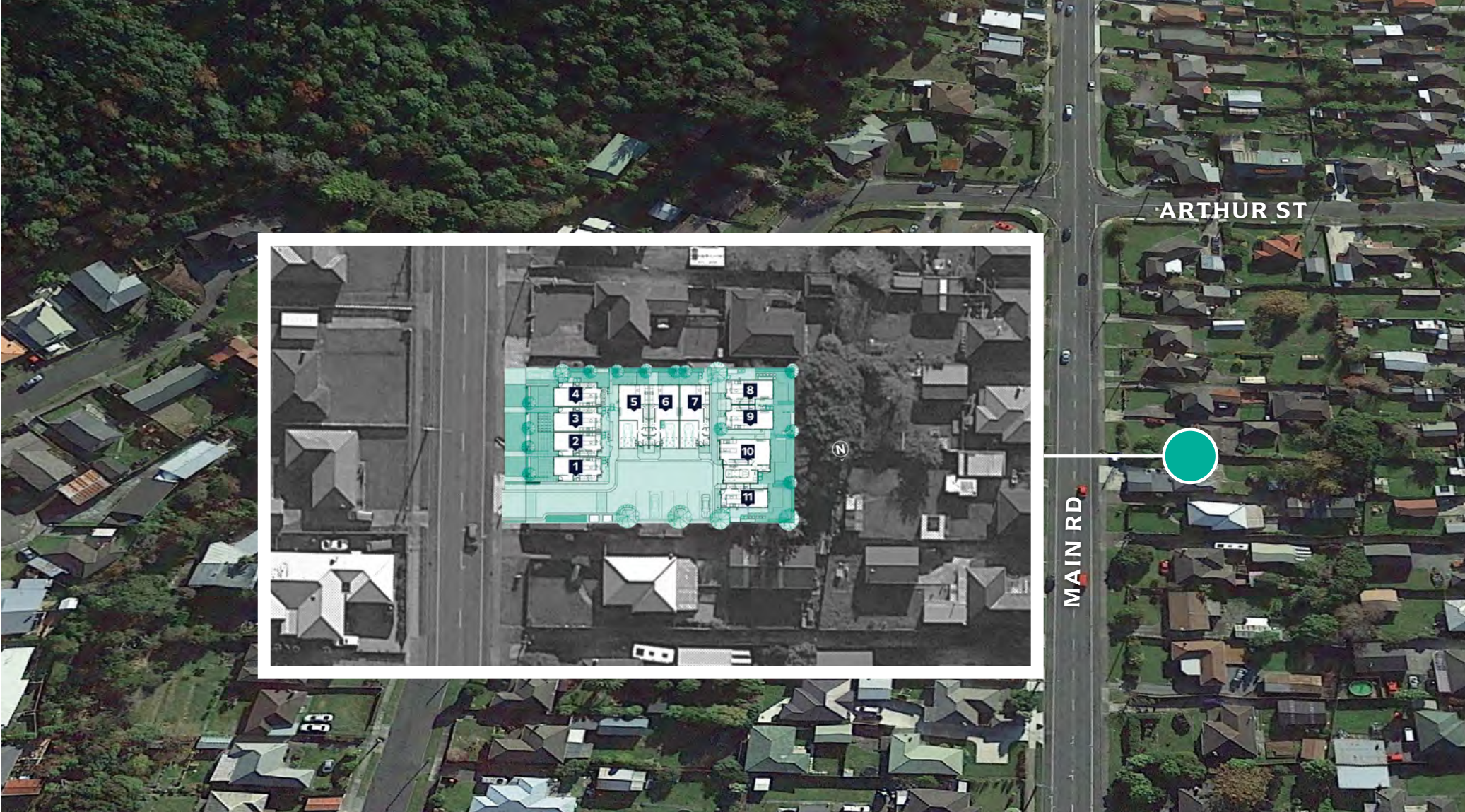



North-East Elevation



South-West Elevation

Lot 3	Ground floor area:	43.27 m <sup>2</sup>
	First floor area:	37.2 m <sup>2</sup>
	<b>Total Floor area:</b>	<b>80.47 m<sup>2</sup></b>

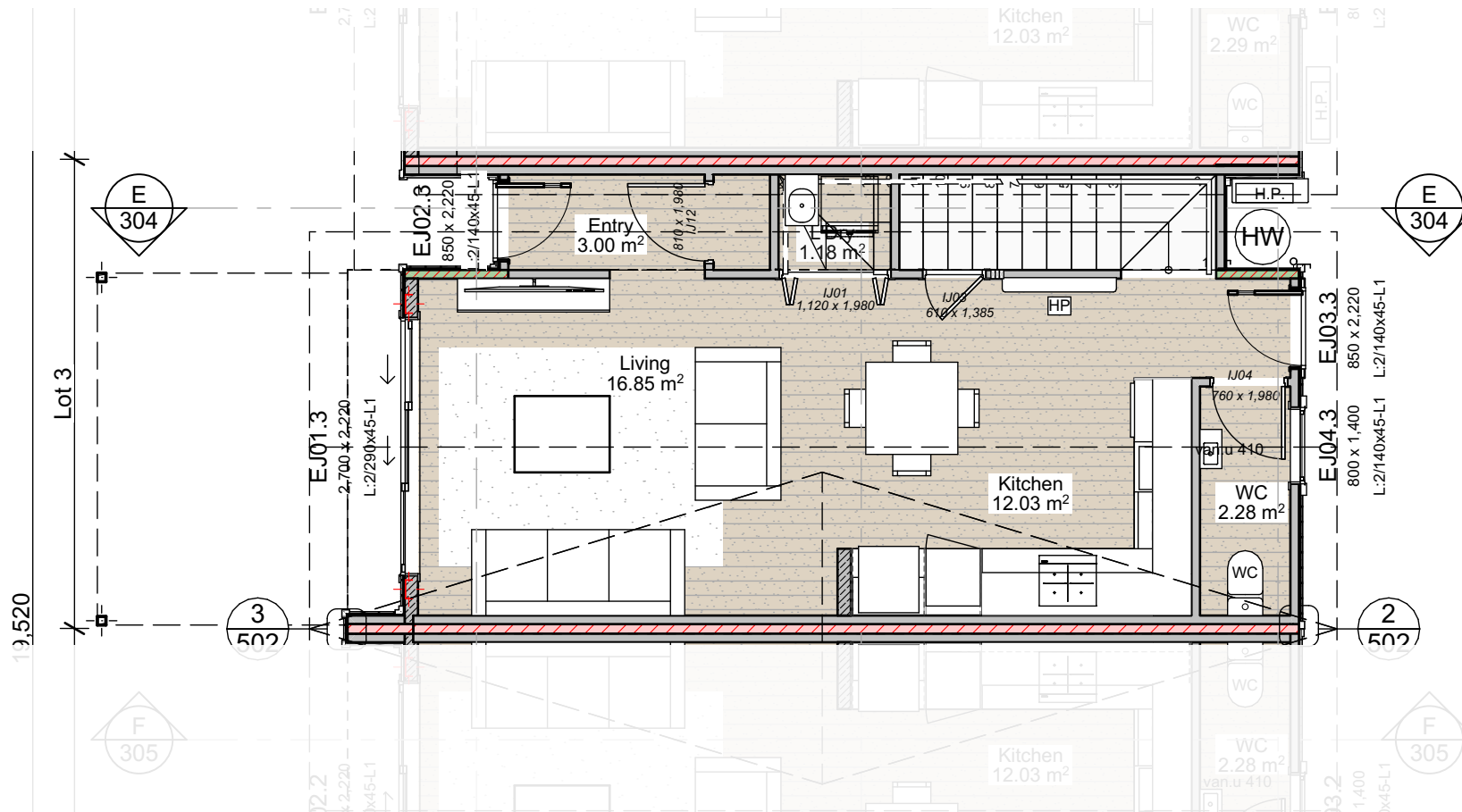

Lot 3	Ground floor area:	43.27 m <sup>2</sup>
	First floor area:	37.2 m <sup>2</sup>
	<b>Total Floor area:</b>	<b>80.47 m<sup>2</sup></b>

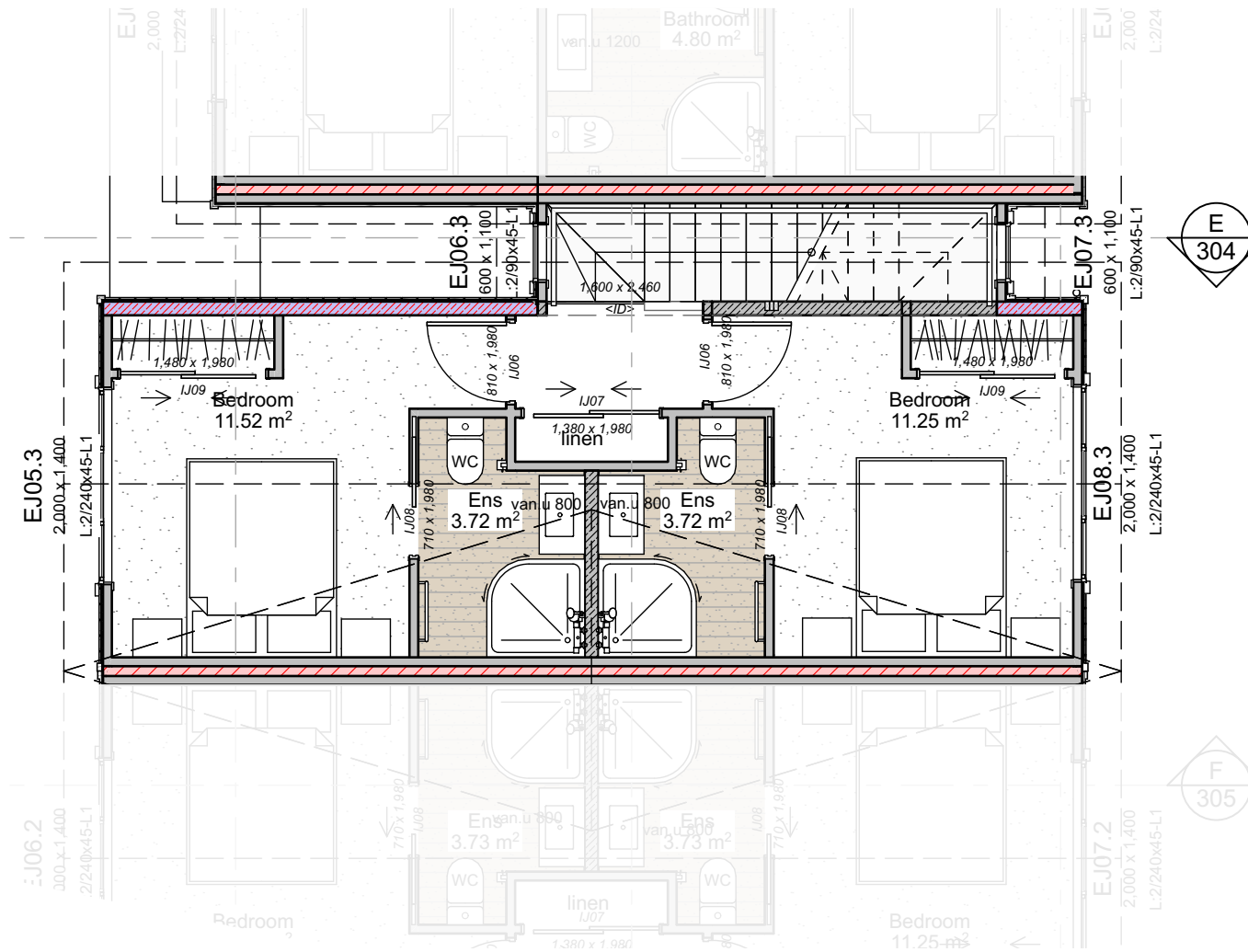

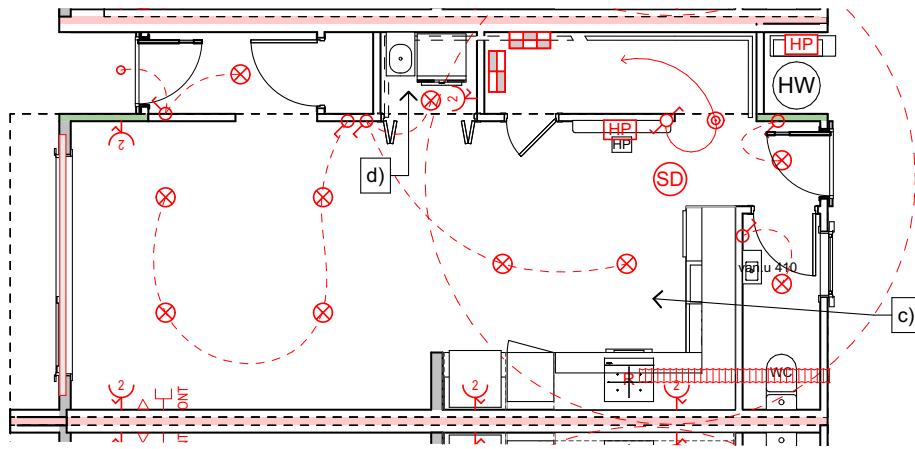

Lower Electrical Plan

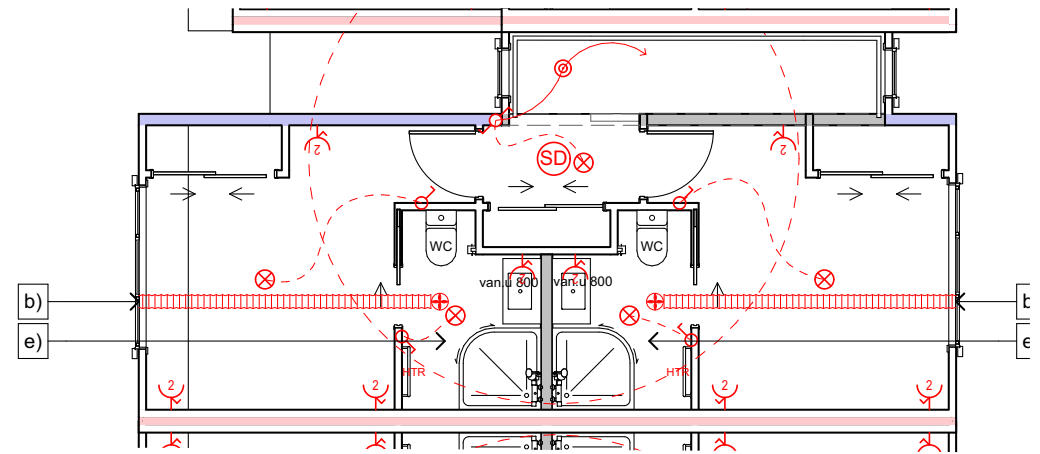

Upper Electrical Plan

	Meter box - Internal Smart Meter		Ceiling mounted exhaust fan, Manrose Pro-series 150mm SFLP150T.		Recessed Downlight
	Distribution board		Hot water cylinder, New Electric.		Security Lighting
	Ceiling mounted light, owner to specify.		Smoke alarms - refer to notes		Data outlet.
	Two way light switch. 1m above floor level TBC.		Heat Pump, owner to confirm		TV outlet
	One way light switch. 1m above floor level TBC.		Rangehood, to be installed to extract a minimum 1,920L/H to suit open plan kitchen, lounge & dining area.		Fibre
	Heated towel rail, built in timer, install switch at comfortable height to owner.		Powerpoint.		

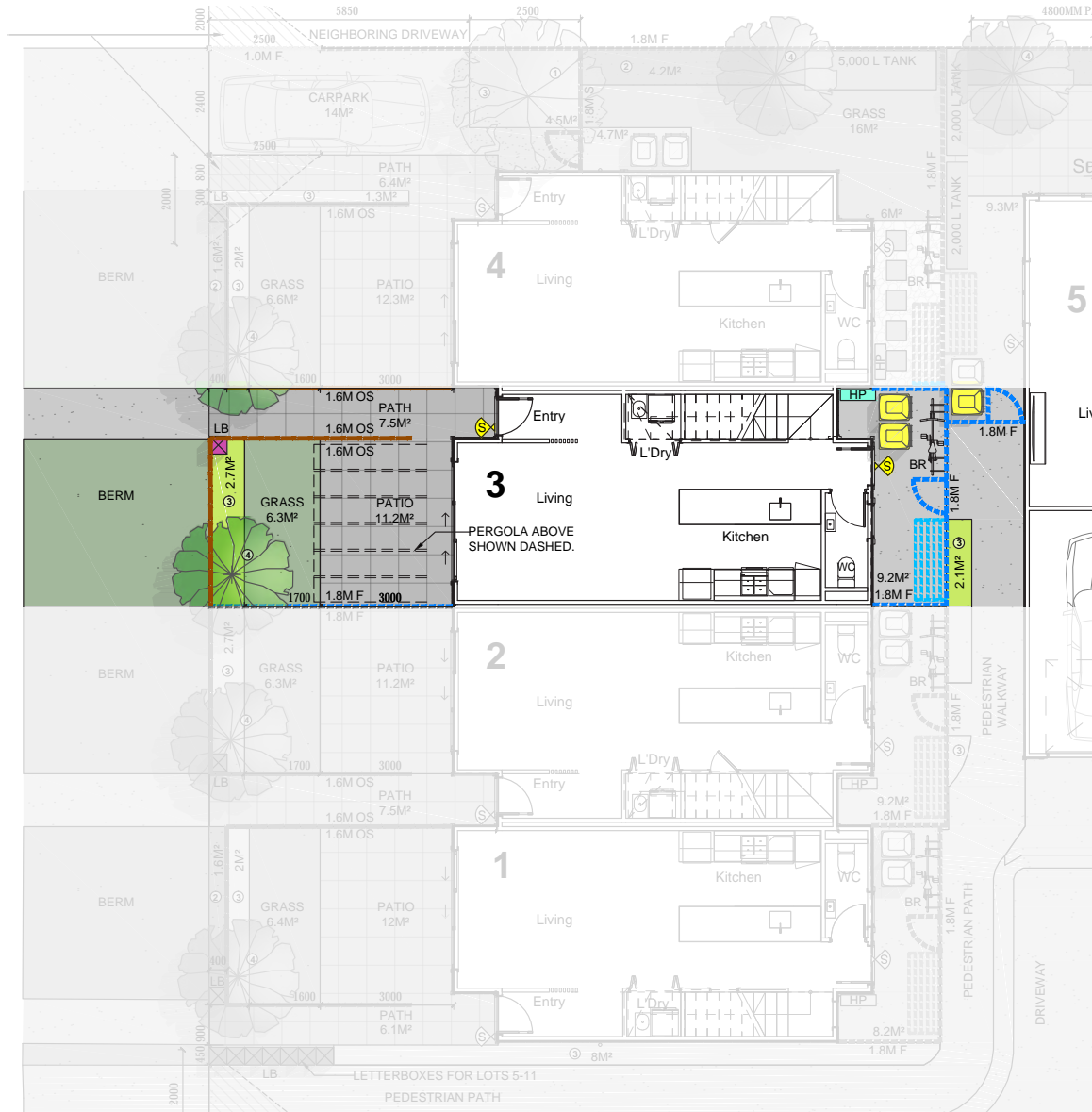



	Product	Colour/Finish
<b>EXTERIOR</b>		
Roof	Colorsteel Corrugated	Flaxpod
Fascia/Barge Boards	Timber, painted	Wattyl Enclose Half
Spouting	Colorsteel	Flaxpod
Downpipes	Marley PVC Coloured (Retention tanks)	Ironsand
Retention Tanks	TBC	TBC
Soffits/Eaves	Painted	Wattyl Enclose Half
Cladding 1	Linea weatherboard, painted	Wattyl Dolphin Grey Half
Cladding 2	Axon (vertical) cladding, painted	Wattyl Dug Out
Cladding 3	Window facings, boxed corners, (verandah beam and posts if applicable), painted	Wattyl Enclose Half
Concrete Letterbox	Nil	
Garage Door	Nil	
Garage Door Reveal	Nil	
Aluminium Joinery (with clear glass)	Powdercoated	Appliance White
(Residential Hardware to all aluminium joinery is colour matched to joinery)		
Front Door	Vertical Groove	Flaxpod
Front Door Handle	Residential Lever Hardware	Powdercoat finish matched to door

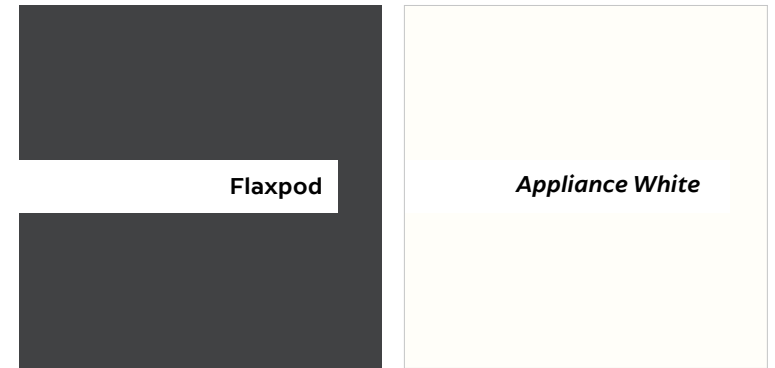

Roof

Aluminium Joinery



Cladding 1

Cladding 2

*All colour swatches are indicative only*